



Technical Sciences
Academy of Romania
www.jesi.astr.ro

Journal of Engineering Sciences and Innovation

Volume 9, Issue 2 / 2024, pp. 105 - 112

A. Mechanical Engineering

Received 21 March 2024

Accepted 14 June 2024

Received in revised form 19 May 2024

Using principal response analysis in rotordynamics

MIRCEA RADEȘ*

*Romanian Academy of Technical Sciences
National University for Science and Technology Politehnica București,
Splaiul Independenței 313, Bucharest, Romania*

Abstract. The dynamic behavior of rotating structures is described by non-symmetric stiffness and damping matrices. In such non-self-adjoint systems, reciprocity no longer apply. Some mode indicator functions widely used to determine the significant modes present in a given frequency range cannot be used. The paper reports experience in using mode indicator functions based on principal response functions in the case of measurements made on a rotor test rig.

Keywords: Mode Indicator Functions, CoMIF, rotor-bearing systems.

1. Introduction

Rotor-bearing systems are usually modeled as an assemblage of rigid discs, distributed mass and stiffness shafts, and discrete bearings and seals. The stiffness matrix is usually unsymmetrical due to the cross coupling terms of hydrodynamic bearings.

It is common practice to use precession speed maps constructed as plots of the damped natural frequencies (DNFs) as a function of the rotor rotational speed. When these plots contain the unbalance excitation line overlaid they are referred to as Campbell diagrams. At any rotational speed, the DNFs are determined by the ordinates of the crossing points of the curves with the corresponding vertical line. Using a steady-state harmonic excitation force applied to the rotor running at constant speed, the frequencies of the peaks in the corresponding Frequency Response Function (FRF) plots give good approximations of the DNFs at that speed.

*Correspondence address: mircearades@gmail.com

The precession speed map can be constructed based on measurements at several running speeds. Observe that peak response natural frequencies are slightly different from the DNFs due to the non-proportional damping.

Mode Indicator Functions (MIFs) are used to estimate the number of resonant modes active in a given frequency band. Some MIFs work on compound matrices encompassing all available complex FRFs. When the Compound FRF (CFRF) matrix is subjected to a Singular Value Decomposition (SVD), it is expressed as a sum of rank-one matrices, referred to as *principal components*.

Each principal component matrix can be expressed as the product of a singular value times a left singular vector (LSV), and the conjugate transpose of the corresponding right singular vector. The Principal Response Functions (PRFs), defined as the LSVs scaled by the respective singular values, are linear combinations of the measured FRFs and have peaks at the natural frequencies.

This paper compares the performance of two MIFs based on PRFs applied to measurement data obtained on a rotor test rig.

2. Tested structure

The measurement data used in this paper were taken on a rotor test rig designed for rotor dynamic experiments at the University of Kassel [1]. Details on the rotor test stand set-up are described in [2, 3].

Two rigid discs and a coupling disc are fixed on a steel shaft supported in plain circular journal bearings. The rotor configuration and numbering of measurement planes are shown in fig.1.

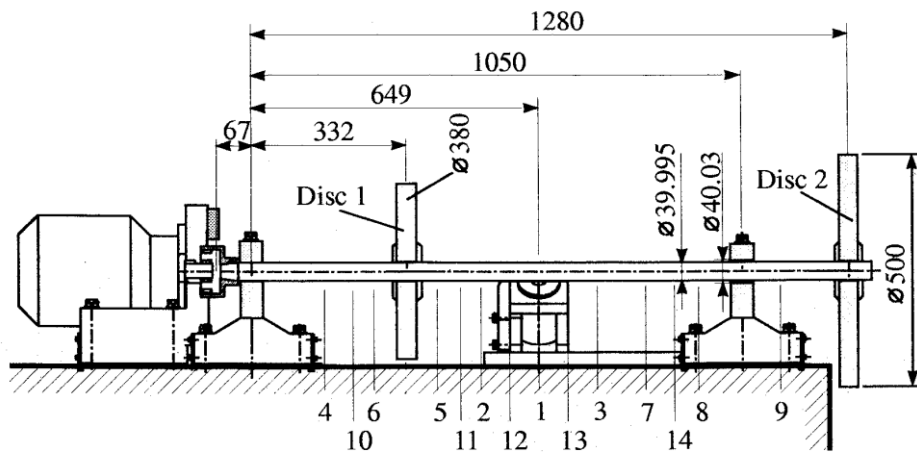

Fig. 1. Tested rotor and measurement planes.

The two discs have masses 35.19 kg and 61.65 kg respectively, and diametral moments of inertia 0.3258 kgm^2 and 0.9789 kgm^2 . The two bearings are plain cylindrical, of length 30 mm and radial clearance $17.5 \mu\text{m}$.

The rotor is driven by an asynchronous motor, coupled to the shaft by a contactless magnetic coupling. The displacements are detected in 14 measurement planes, by contactless sensors, using two orthogonal sensors in each plane. A harmonic force is applied to the rotor by a contactless magnetic exciter which can be placed at various stations along the rotor.

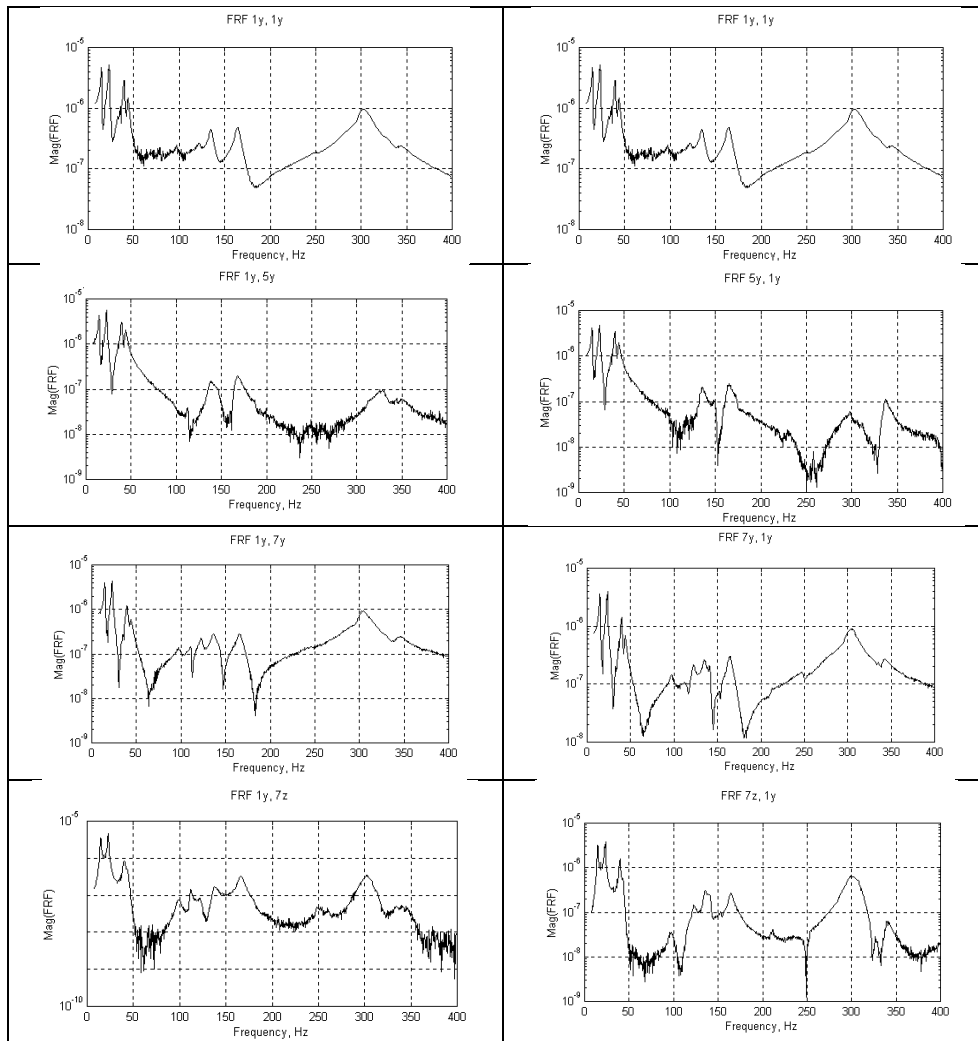

Fig. 2. FRF curves.

3. FRF measurements

The experimental data-base consists of 56 complex-valued FRFs measured, at constant running speed 1080 rpm, in the range 8 to 403.901 Hz with a resolution of 0.387 Hz (1024 frequency lines), using harmonic excitation.

Due to the asymmetry of system matrices, the FRF matrix is unsymmetrical. It is necessary to measure at least one row and one column of the FRF matrix.

The first 28 FRFs are measured at 28 coordinates, two in each of the 14 locations along the rotor, with a horizontal force applied at point 1. The other 28 FRFs are measured at point 1 in the horizontal direction with the force applied along the 28 coordinates in turn.

Selected receptance frequency response functions FRF_{jk} , for displacement at coordinate j produced by excitation at coordinate k , are represented as magnitude (log scale) versus frequency (linear scale) plots in Fig. 2.

As expected, the diagrams FRF_{jk} and FRF_{kj} are not identical. At each running speed, the FRF matrix contains only the first row and the first column. Because the diagonal elements FRF_{jj} , except the first, are not measured, mode indicator functions like the $CMIF$ and the $MMIF$ [4] cannot be calculated.

Note that FRFs measured at a given running speed may have peaks due to the inherent unbalance excitation, apart from the peaks due to the applied harmonic excitation force.

4. The Componentwise Aggregate Mode Indicator Function (CAMIF)

The CAMIF is defined by vectors of the form

$$CAMIF_i = p_i \otimes p_i^*, \quad (1)$$

where p_i are frequency dependent principal response vectors. Its plots versus frequency have peaks at the damped natural frequencies. The star superscript denotes the complex conjugate and \otimes denotes element-by-element vector product.

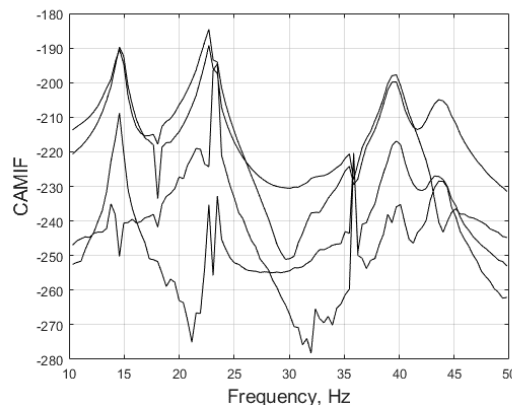

Fig. 3. CAMIF plot in the range 10 to 50 Hz.

It is recommended to use CAMIF plots for restricted frequency ranges. The CAMIF plot for the frequency range 10 to 50 H is shown in fig.3. It reveals the first four modes of precession at 14.58, 23.48, 39.73 and 43.6 Hz, respectively. Their shapes are shown in Fig. 4.

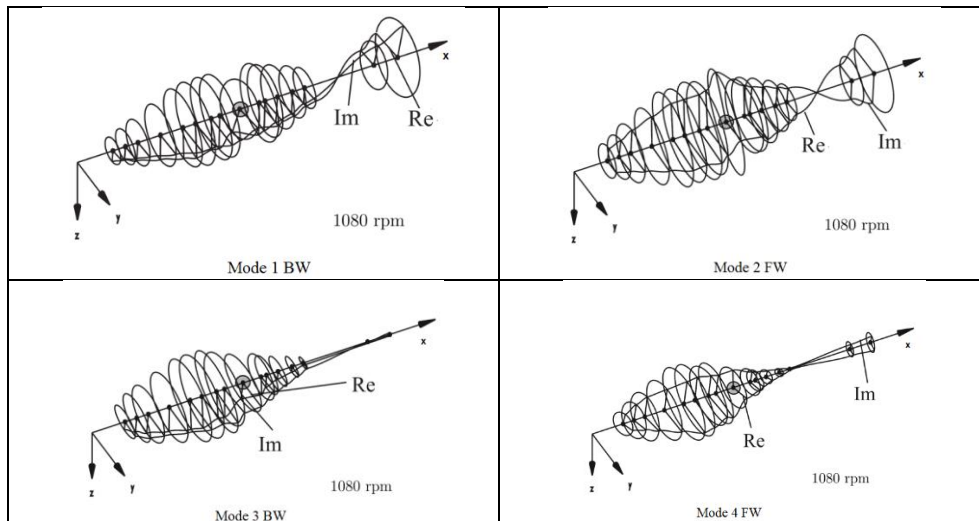

Fig. 4. Mode shapes in the range 10 to 50 Hz.

The CAMIF plot for the frequency range 50 to 350 Hz is shown in fig. 5. It reveals other six modes of precession at 97.8, 122.5, 135.7, 164.7, 303.7 and 344.7 Hz.

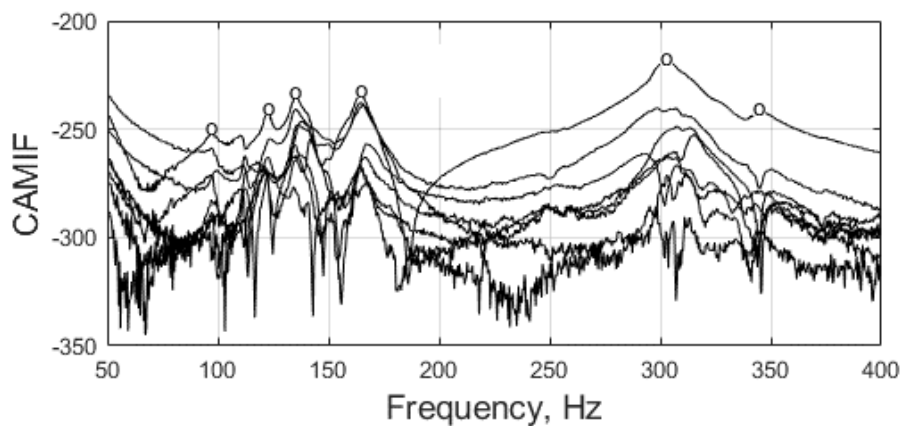

Fig. 5. CAMIF plot in the range 50 to 350 Hz.

5. The Componentwise Mode Indicator Function (CoMIF)

In the basic formulation [5] the CoMIF is defined by vectors of the form

$$CoMIF_i = [1] - u_i \otimes u_i^*, \tag{2}$$

where u_i are left singular vectors of the compound FRF matrix.

In this paper, the CoMIF is defined as

$$CoMIF_i = [1] - p_i \otimes p_i^*, \tag{3}$$

where p_i are principal response vectors. Its plot versus frequency has dips at the damped natural frequencies.

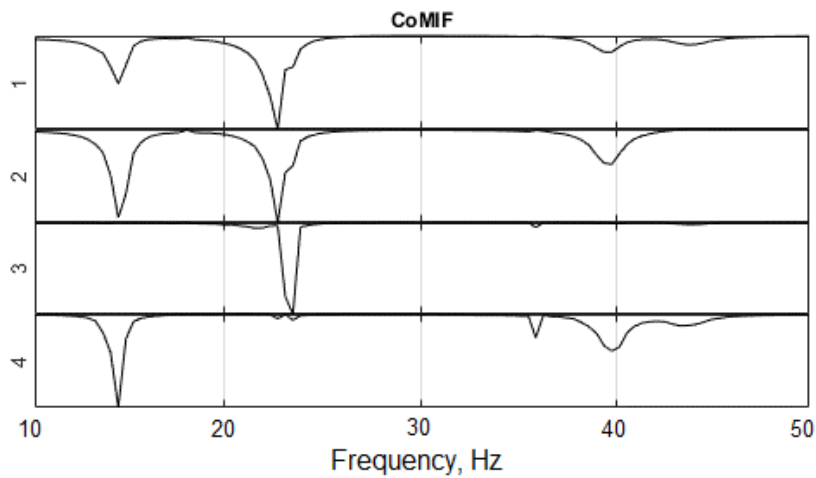

Fig. 6. CoMIF plot in the range 10 to 50 Hz.

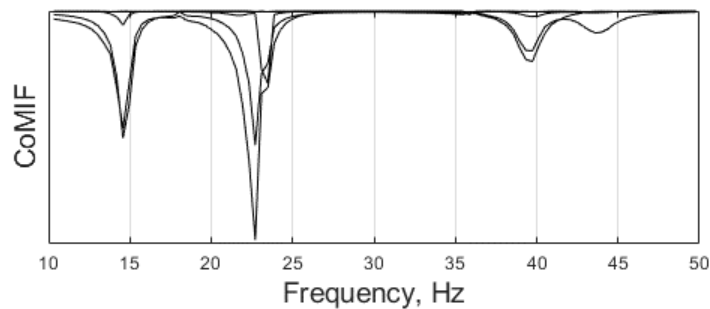

Fig. 7. Overlaid CoMIF plot in the range 10 to 50 Hz.

The CoMIF plot for the frequency range 10 to 50 Hz is shown in fig.6. It has dips at 14.58, 23.48, 39.73 and 43.6 Hz. The corresponding overlaid CoMIF plot is given in fig. 7.

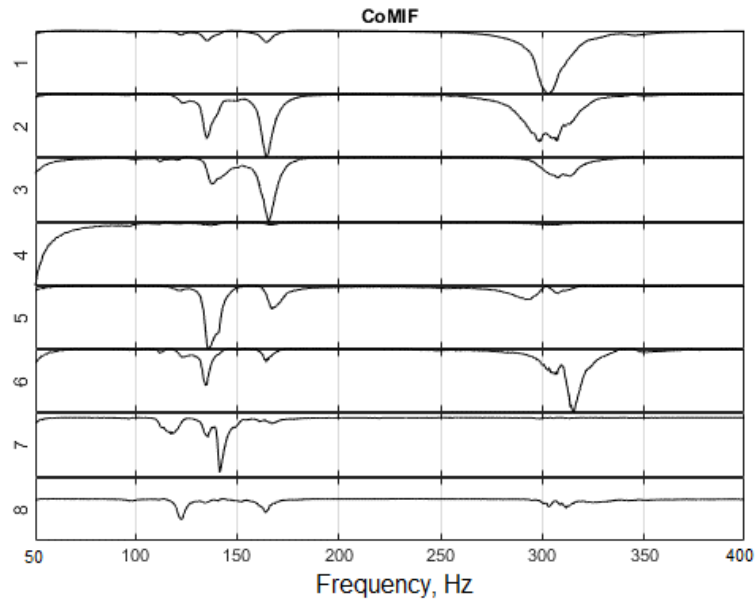

Fig. 8. CoMIF plot in the range 50 to 350 Hz.

The CoMIF plot for the frequency range 50 to 350 Hz is shown in fig.8. It has dips at 122.5, 135.7, 164.7, 303.7 and 344.7 Hz. The deepest minimum in each curve marks the natural frequency of the dominant mode of precession. It fails to locate the mode at 97.8 H.

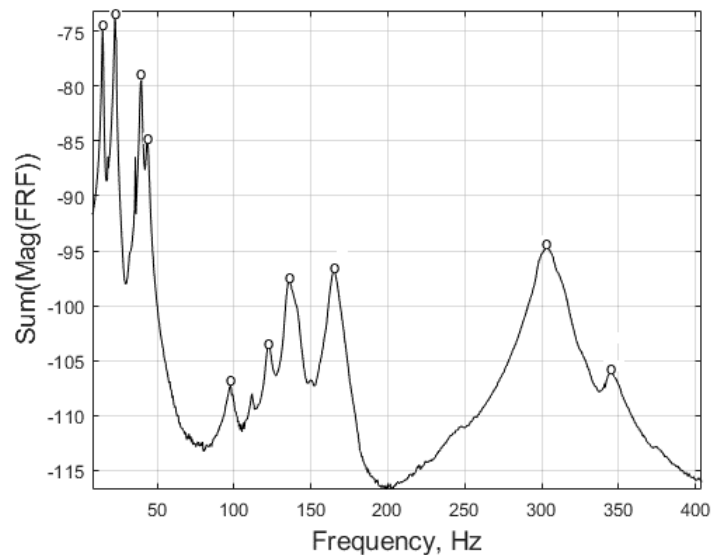

Fig. 9. Plot of the sum of maximum absolute values of FRFs.

For comparison, a single curve MIF is given in fig. 9 as a plot of the sum of the maximum absolute values of all FRFs as a function of frequency. It works well for rotor-bearing systems with distinct natural frequencies.

6. Concluding remarks

The aim of this paper was to assess the performance of two principal response MIFs in the analysis of rotor-bearing systems, based on FRFs measured using steady-state harmonic excitation forces applied to the running rotor.

A laboratory rotor test rig has been selected, equipped with contactless sensors, a force magnetic exciter and a driving motor. As experiments were carried out for the modal analysis of the rotor by the orthogonal polynomial technique, it was necessary to measure only one row and one column of the FRF matrix.

This restricted the selection of mode indicator functions to those based on the principal response analysis of compound FRF multi-frequency matrices.

It turned out that, with adequate interpretation, CoMIFs and CAMIFs are reliable tools for the determination of the precession modes active in a given frequency band.

Principal response vectors have to be used instead of left singular vectors in order to attenuate or eliminate the peaks or dips produced by the mass unbalance of the running rotor.

The key point is the appropriate selection of the frequency range of analysis, and the number of subplots or component curves. The values of the damped natural frequencies obtained from MIFs can be used to the construction of precession speed maps.

References

- [1] Lindeman S., *Model Updating an einem biegeelastischen Rotor*, Berichte des Instituts für Mechanik, Kassel University Press, Bericht 1, 2009.
- [2] Kreuzinger-Janik T., *Modalanalysegestützte Unwuchtidentifikation an einem Rotorversuchsstand*, PhD thesis, Universität Kassel, 1997.
- [3] Kreuzinger-Janik T., Irretier H., *On modal testing of flexible rotors for unbalance identification*, Proc. 16th Int. Modal Analysis Conf., Santa Barbara, CA, Feb. 1998, p. 1533-1539.
- [4] Radeş M., *Performance of various mode indicator functions*, Shock and Vibration, **17**, 4-5, 2010, p. 473-482.
- [5] Radeş M., Ewins D.J., *The Componentwise Mode Indicator Function*, Proc. 19th Int. Modal Analysis Conf., Kissimmee, Florida, 2001, p. 903-908.