



Technical Sciences
Academy of Romania
www.jesi.astr.ro

Journal of Engineering Sciences and Innovation

Volume 9, Issue 1 / 2024, pp. 15-22

A. Mechanical Engineering

Received 23 October 2023

Accepted 22 March 2024

Received in revised form 19 February 2024

Locating excitation points in structural dynamic testing

MIRCEA RADEȘ*

Politehnica University of Bucharest, Splaiul Independenței 313, Bucharest, Romania

Abstract: This paper reports experience in using modal identifiers for the placement of exciters in structural dynamic testing. A low-order model is examined to eliminate the need to determine the model order and the optimal location of response sensors. The procedure is applied to a ten degrees of freedom lumped parameter system with high modal density and moderate damping.

Keywords: exciter placement, Mode Indicator Functions, UMIF, CoMIF.

1. Introduction

When constructing models of practical structures, Mode Indicator Functions (MIFs) and stability diagrams are used to detect the relevant modes which have to be included in the summation made to compute the response functions [1].

For low-order systems, the number of modes can be taken equal to the total number of degrees of freedom (DOF). When applicable, it can be determined by simply counting peaks or troughs on MIF plots. For the adequate definition of the mode shapes, the displacements of all lumped masses can be selected as response locations.

The remaining task is to find the force distribution able to excite all the modes of vibration from a minimum number of locations. The optimal placement of reference points ensures the proper discrimination of the modes of interest. Excitation in at least two points is required by the existence of closely coupled modes. A method was presented in [2] for the location of optimum reference points from the point of view of independence of the mode shapes.

This paper presents a locating technique based on MIFs. The optimal configuration is selected when the MIF locates all resonances and each curve is dominated by a single mode of vibration.

* Correspondence address: mircearades@gmail.com

2. Tested structure

The data used in this paper have been generated for the 10 degrees of freedom lumped parameter system shown in Fig.1.

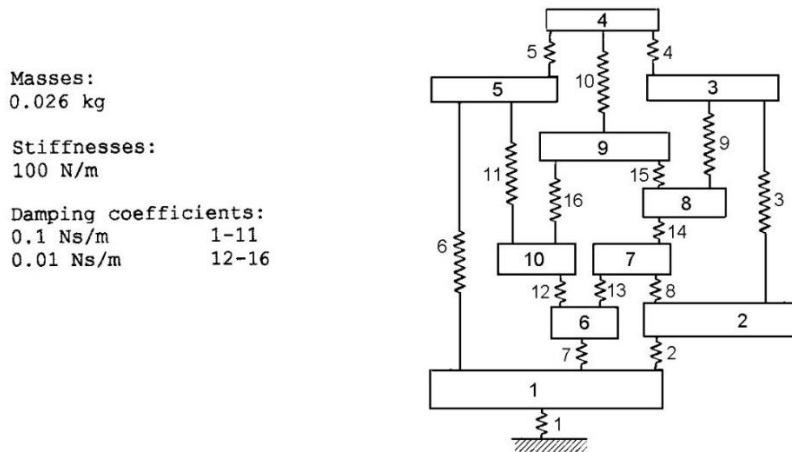

Fig.1. 10 DOF system.

The ten masses interconnected by springs are distributed along two concentric groups, 1 through 5 and 6 through 10. The five masses numbered 6 to 10 are connected by damping elements one order of magnitude smaller than the others.

3. Natural frequencies and mode shapes

The damped natural frequencies and modal damping ratios are given in Table 1. The system has a cluster of four natural frequencies and two pairs of close modes.

Table 1. Eigenfrequencies and damping ratios of the 10 DOF system

Mode	Natural frequency, Hz	Damping ratio, %	Mode	Natural frequency, Hz	Damping ratio, %
1	2.67	0.823	6	18.396	4.51
2	11.60	2.00	7	18.813	3.22
3	12.19	2.11	8	19.606	3.36
4	14.28	4.37	9	23.303	5.24
5	18.125	4.65	10	23.849	5.99

The complex modes of vibration are shown in Fig.2 as Argand diagram ‘starburst’ (compass) graphs. They are quasi-real modes with small phase shifts.

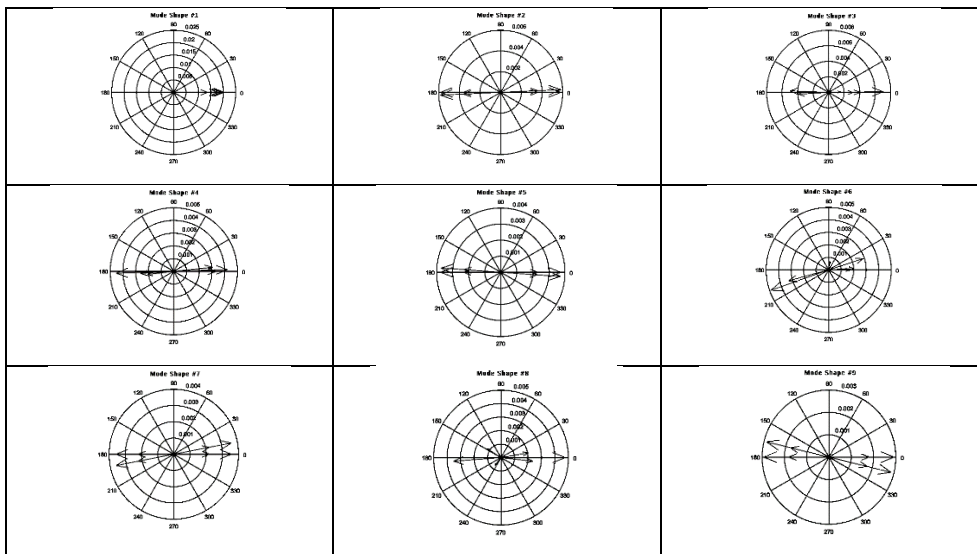

Fig. 2. Complex modes of vibration.

The real parts of the complex modal vectors are listed in Table 2.

Table 2. Real parts of modal vectors of the 10 DOF system

	Mode									
	1	2	3	4	5	6	7	8	9	10
	Real part									
1	0.676	0	0.577	-0.741	0	-0.325	0	1	0	1
2	0.889	-0.996	0.215	-0.933	1	-0.591	0.596	-0.213	-0.618	-0.591
3	0.981	-0.616	-0.708	-0.679	0.618	0.674	-0.965	-0.096	1	0.198
4	0.981	0.616	-0.708	-0.679	-0.618	0.674	0.965	-0.096	-1	0.198
5	0.889	0.996	0.215	-0.933	-1	-0.591	-0.596	-0.213	0.618	-0.591
6	0.877	0	1	0.456	0	1	0	0.495	0	-0.662
7	0.945	-1	0.448	0.5796	-0.993	-0.069	0.618	-0.736	0.587	0.479
8	1	-0.618	-0.554	1	-0.613	-0.398	-1	0.424	-0.949	-0.170
9	1	0.618	-0.554	1	0.613	-0.398	1	0.424	0.949	-0.170
10	0.945	1	0.448	0.579	0.993	-0.069	-0.618	-0.736	-0.587	0.479

4. Frequency response functions

Complex receptance frequency response functions FRF_{jk} were computed for displacement at mass j produced by excitation at the mass k . Figure 3 shows the noise-free driving point FRFs, represented as magnitude (log scale) versus frequency (linear scale) plots. All exhibit blunt resonances and do not show the close modes.

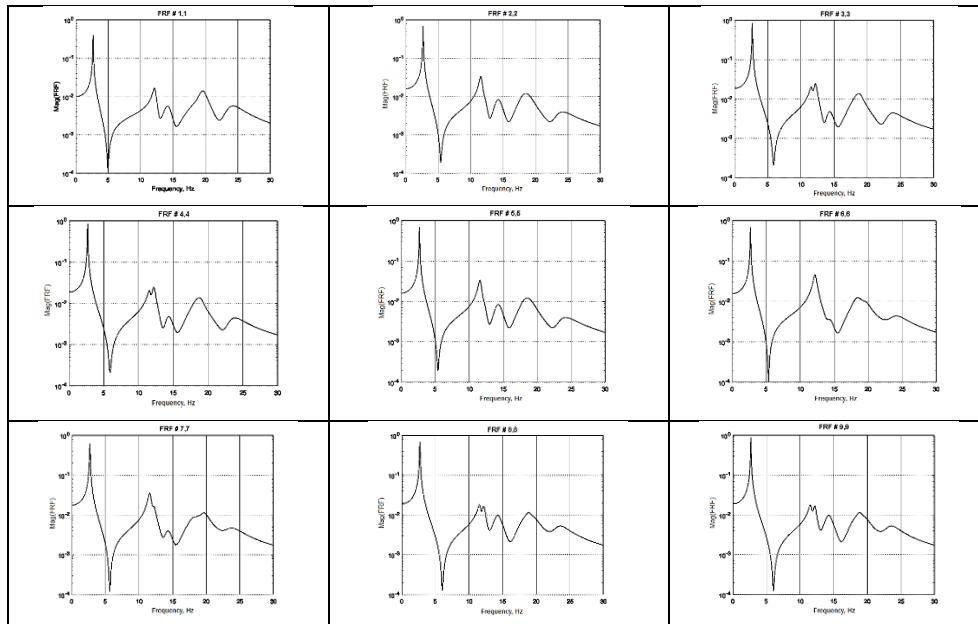

Fig. 3. Driving point FRF curves.

5. The U-Mode Indicator Function (UMIF)

Suppose the available “test” data are under the form of Frequency Response Functions (FRFs), arranged column wise in a composite FRF (CFRF) matrix. A singular value decomposition (SVD) is performed on this matrix. The left singular vectors (LSV) contain the frequency distribution of energy, being linear combinations of the columns of the CFRF matrix.

The *U-Mode Indicator Function* (UMIF) is a plot of the left singular vectors of the CFRF matrix as a function of frequency [3]. For an adequate selection of input/output coordinate combinations, each LSV is dominated by a single mode of vibration and can be used to locate the corresponding natural frequency. UMIF has peaks at the damped natural frequencies.

For the construction of the UMIF, a simulated test data set was generated by assuming that the system is excited on two masses, and the response at all ten masses is “measured” at frequencies between 1-30 Hz, with 0.06 Hz frequency resolution.

The small number of DOFs of the analyzed system prevents any discussion on the spatial resolution.

First, excitation at masses 4 and 6 was selected, based on the comparison of MIFs calculated for different pairs of points. The UMIF based on the CFRF matrix, with input in 4 and 6, and output in 1 through 10 is shown in Fig.4. The UMIF locates all ten modes of vibration, including the double modes at about 12 Hz and 23 Hz, as well as the cluster of four frequencies at about 18 Hz.

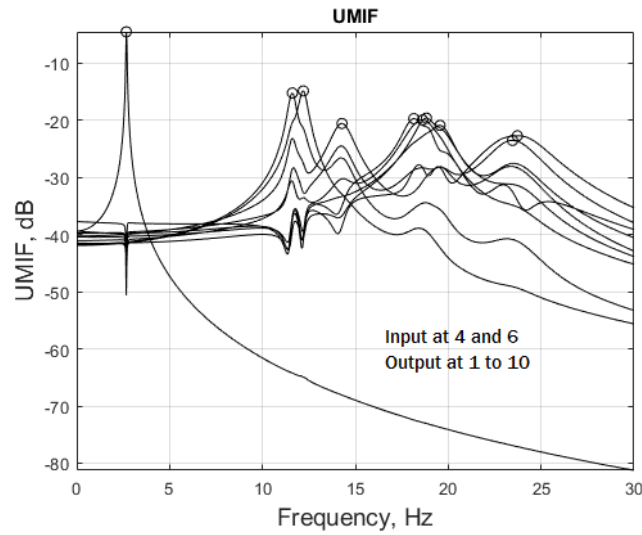

Fig. 4. UMIF plot for excitation in 4 and 6

The UMIF plot calculated for input in 3 and 10, and output in 1 through 10 is shown in Fig.5. Again, the UMIF locates all ten modes of vibration.

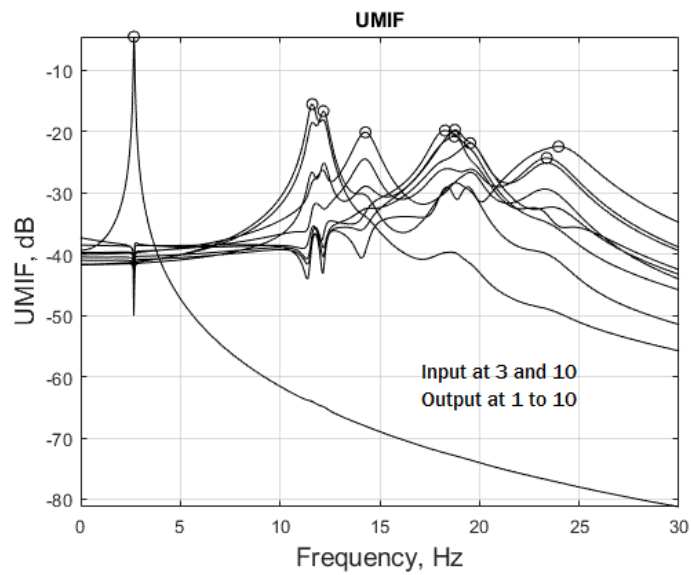

Fig. 5. UMIF plot for excitation in 3 and 10

6. The Componentwise Mode Indicator Function (CoMIF)

The *Componentwise Mode Indicator Function* (CoMIF) is basically an inverted squared UMIF plot. It is defined [4] by vectors computed as the difference between a column vector of ones and the element-by-element product of the left singular vectors of a CFRF matrix having the FRFs as columns. For this simple example, the number of curves is taken equal to the number of DOFs. The CoMIF has dips at the damped natural frequencies. For an adequate selection of input/output coordinate combinations, the deepest trough in each subplot locates a mode of vibration.

FRFs have been generated assuming that the system is excited on masses 4 and 6, and the response is calculated at all ten masses. This amounts to a total of 20 FRFs calculated at frequencies between 1-30 Hz with 0.06 Hz frequency resolution.

The CoMIF plot calculated for input in 4 and 6, and output in 1 through 10 is shown in Fig.6. It locates all ten modes of vibration.

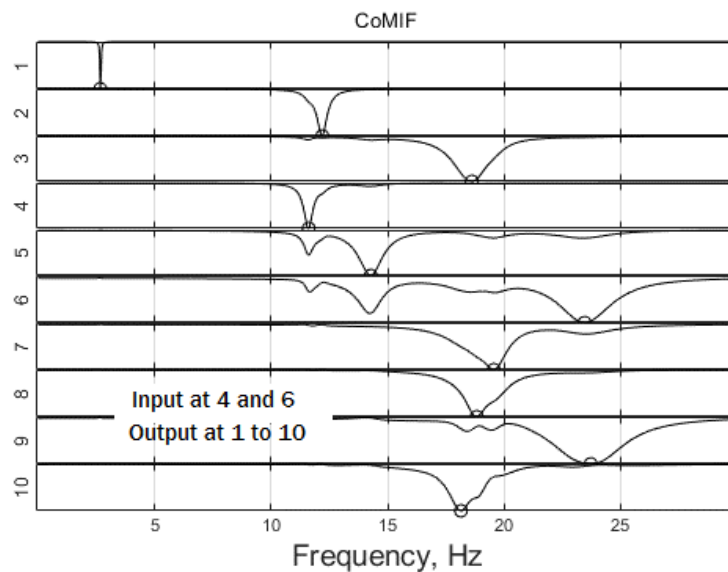

Fig. 6. CoMIF plot for excitation in 4 and 6.

The CoMIF plot calculated for input in 3 and 8 is given in Fig.7. It locates all ten resonances at the deepest trough in each component graph.

Due to the particular configuration of the analyzed system, there are ten combinations of two input points able to decouple the modes: 3-6, 3-7, 3-8, 3-9, 3-10 and 4-6, 4-7, 4-8, 4-9, 4-10. They contain the points 3 and 4 from the outer group taken together with one of the five points from the inner group. Comparing figures 6 and 7 it is obvious that excitation in 4 and 6 provides a better isolation of modes than the excitation in 3 and 8.

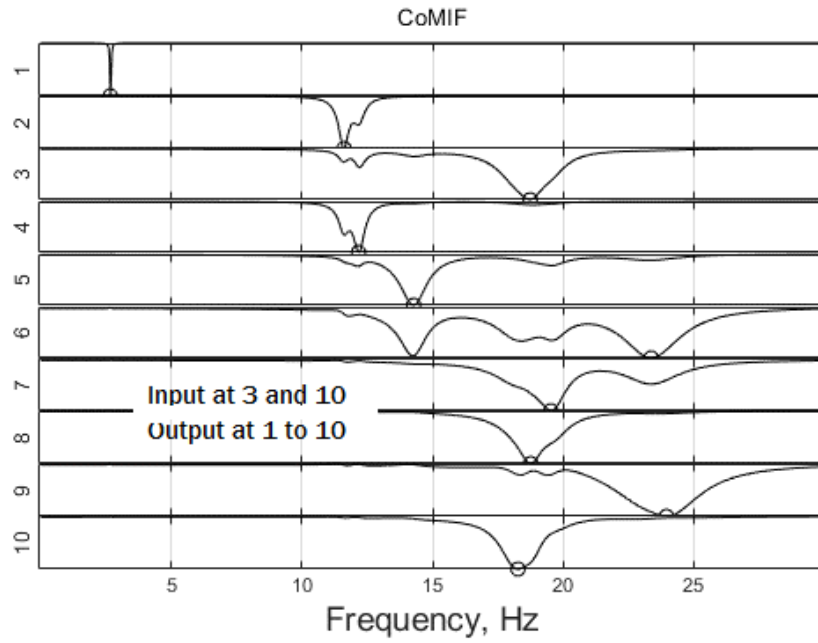

Fig. 7. CoMIF plot for excitation in 3 and 8.

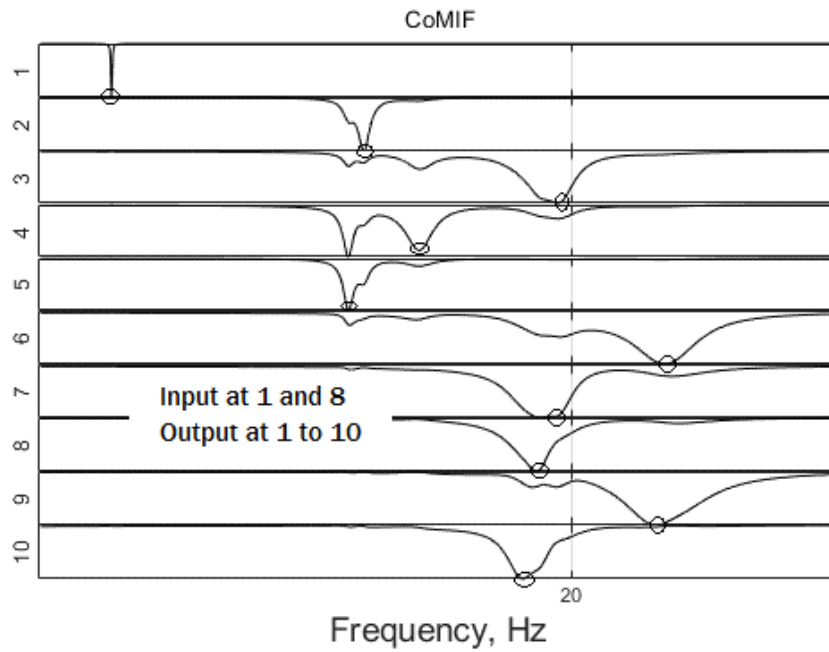

Fig. 8. CoMIF plot for excitation in 1 and 8.

The method is not always effective. It is appropriate to consider here the consequences of applying an improper excitation configuration. The CoMIF plot computed for input in 1 and 8, shown in Fig.8, needs some interpretation. Subplots CoMIF5 and CoMIF2 locate the second and third natural frequencies at the only through. The subplot CoMIF4 has two minima. As the first minimum locates a frequency already selected at the single deep in CoMIF5, the corresponding natural frequency is located by the second minimum even it is not the deepest.

A judicious selection of excitation points is of paramount importance. Generally, trying more than one exciter configuration ensures the proper discrimination of the modes of interest. The optimal placement of excitation points is obtained when the subplots in CoMIF have a single minimum. Moreover, good results are obtained when the excitation configuration generates approximately equal levels of response in the various modes of interest.

Construction of MIFs based on FRFs generated with excitation at more than two points do not necessarily provide a better location of resonances.

7. Concluding remarks

The aim of this simple case study was to document the ability of two modal indicators to locate the resonances of a moderately damped simple system, with high modal density, and to help in the selection of reference points. An optimal exciter placement is obtained when the MIF locates all resonances and each curve is dominated by a single mode of vibration. Further analysis of each peak in UMIF yields the modal parameters by routine techniques.

A low-order model was used to eliminate the problem of proper placement of response points. For an improper selection of the excitation points, the modes cannot be simply uncoupled and the procedure requires some skill to be implemented.

References

- [1] Radeş M., *Performance of various mode indicator functions*, Shock and Vibration, **17**, 4-5, 2010, p. 473-482.
- [2] Radeş M., *Actuator and sensor location for structural identification and control*, Proc. IUTAM Symp., Interaction between Dynamics and Control in Advanced Mechanical Systems (ed. D.H. van Campen), Eindhoven, 21-26 April 1996, p. 329-336.
- [3] Radeş M., *Displays of Vibration Properties*, Encyclopedia of Vibration (eds. S. Braun, D. Ewins, S.S. Rao), Academic Press, London, 2002, p. 413-431.
- [4] Radeş M., Ewins D.J., *The componentwise mode indicator function*, Proc. 19th Int. Modal Analysis Conf., Kissimmee, Florida, Feb 2001, p. 903-908.